



USER GUIDE

Cisco Small Business Pro

IP Phone SPA525G (SIP)

FCC and IC Statement	7
Federal Communication Commission Interference Statement	7
IMPORTANT NOTE	7
Industry Canada Statement	8
About This Document	9
Purpose	9
Organization	9
Finding Information in PDF Files	10
	12
Chapter 1: Getting Started	13
Overview of the Cisco SPA525G IP Phone	14
Caring for Your Phone	15
Understanding Your Phone's Lines and Buttons	16
Phone Components	16
Softkey Buttons	18
Using the Keypad and Buttons with Menus	21
Using Keypad Shortcuts	21
Using the Navigation Button	21
Entering Numbers and Text in Fields	22
Using Phone Hardware and Accessories	23
Using the Speakerphone	23
Using Wired and Wireless Headsets	23
Connecting the Headset	23
Connecting Bluetooth Headsets	24
Using a Headset with Your IP Phone	25
Switching Between the Handset/Headset/Speakerphone During a Call	25

Chapter 2: Installing Your Phone	27
Before You Begin	28
Connecting the Handset	28
(Optional) Attaching the Desk Stand	30
(Optional) Mounting the Phone to the Wall	31
Connecting Your Phone's Power	33
Connecting Your Phone to the Computer Network	34
Connecting Your Phone to the Wired Network	34
Connecting Your Phone to the Wireless Network	34
Determining Your Wireless Router Security Type	35
Using Wi-Fi Protected Setup with the SPA525G	38
Manually Adding a Wireless Profile on the SPA525G	39
Uploading Security Certificates to the Phone	41
Verifying Phone Startup	42
Upgrading Your Phone's Firmware	42
Chapter 3: Using Basic Phone Functions	44
Placing or Answering a Call	45
Using Dial Assistance	46
Adjusting Call Volume and Muting	46
Adjusting Call Volume	46
Using Mute	46
Putting a Call on Hold	46
Resuming a Call	47
Ending a Call	47
Transferring Calls	47
Performing an Attended Transfer	47
Performing an Unattended (Blind) Transfer	48
Redialing	48

Viewing and Returning Missed Calls	49
Returning a Missed Call	49
Viewing a List of Missed Calls	49
Turning the Missed Calls Shortcut On and Off	50
Forwarding Calls	50
Forwarding Calls to a Single Number	51
Forwarding Calls When Your Phone is Busy	51
Forwarding Calls When You Don't Answer the Phone	52
Delaying Call Forwarding When You Don't Answer the Phone	52
Stopping Call Forwarding	52
Setting Do Not Disturb	52
Configuring Call Waiting	53
Picking Up a Call	54
Parking a Call	55
Placing a Three-Way Conference Call	56
Using the Phone Directories	57
Using Your Personal Address Book	57
Adding a New Contact	58
Copying a Contact	59
Searching for a Contact	59
Deleting a Contact	59
Editing a Contact	60
Using the Corporate Directory	60
Using the Call History Lists	61
Viewing the Call History Lists	61
Deleting a Call History List	62
Calling from the Call History Lists	62
Deleting an Entry from the Call History Lists	62
Saving a Call History List Number to Your Directory	63

Setting or Changing a Phone Password	63
Logging In and Logging Out of Your Phone	64
Accessing Voicemail	64
Chapter 4: Using Advanced Phone Features	66
Configuring Privacy and Security Features	67
Blocking Caller ID	67
Blocking Anonymous Calls	67
Using Secure Call	68
Enabling Dial Assistance	68
Creating and Using Speed Dials	69
Playing MP3 Files on Your Phone	70
Creating the Playlist	70
Playing Songs	71
Changing the Left and Right Channel for Stereo Headsets	72
Using the Paging Feature	72
Paging Another Phone	72
Configuring Auto Answer	73
Customizing Your LCD Screen	73
Changing the LCD Screen Contrast	73
Setting the Screen Backlight Timer	74
Configuring the Phone Screen Saver	74
Changing the Phone Wallpaper	75
Using Ring Tones	76
Accessing Weather and News on Your Phone	77
Accessing Weather Information	77
Accessing News	78
Configuring Date and Time Parameters on Your Phone	79
Using Star Codes	80
Restarting Your Phone	82

Viewing Phone, Network, and Call Information	82
Viewing Phone Information	82
Viewing Network Information	83
Viewing Phone Line and Extension Information	83
Viewing Peripheral Status	84
Viewing the Wireless Connection Status	84
Advanced Menus for Technical Support Personnel	85

Chapter 5: Using the Web Interface **86**

Logging in to the Web Interface	87
Configuring Your Address Book	87
Setting Do Not Disturb	88
Configuring Call Forwarding	89
Configuring Call Waiting	90
Blocking Caller ID	90
Blocking Anonymous Calls	91
Viewing Call History Lists	91
Creating Speed Dials	92
Configuring Wi-Fi	92
Configuring Bluetooth	93
Upgrading Firmware	94

Chapter 6: Using the SPA932 Attendant Console **95**

Connecting the SPA932 Attendant Console to the SPA525G IP Phone	96
Connecting a Single SPA932	96
Connecting an Additional SPA932	100
Using the SPA932 Attendant Console with Your SPA525G IP Phone	101
Monitoring the SPA932	102

Appendix A: Additional Information	103
Regulatory Compliance and Safety Information	103
Warranty	103
End User License Agreement (EULA)	103
Support Contacts	103
Appendix B: Where to Go From Here	104
Product Resources	104
Related Documentation	105

FCC and IC Statement

Federal Communication Commission Interference Statement

This equipment has been tested and found to comply with the limits for a Class B digital device, pursuant to Part 15 of the FCC Rules. These limits are designed to provide reasonable protection against harmful interference in a residential installation. This equipment generates, uses and can radiate radio frequency energy and, if not installed and used in accordance with the instructions, may cause harmful interference to radio communications. However, there is no guarantee that interference will not occur in a particular installation. If this equipment does cause harmful interference to radio or television reception, which can be determined by turning the equipment off and on, the user is encouraged to try to correct the interference by one of the following measures:

- Reorient or relocate the receiving antenna.
- Increase the separation between the equipment and receiver.
- Connect the equipment into an outlet on a circuit different from that to which the receiver is connected.
- Consult the dealer or an experienced radio/TV technician for help.

FCC Caution: Any changes or modifications not expressly approved by the party responsible for compliance could void the user's authority to operate this equipment.

This device complies with Part 15 of the FCC Rules. Operation is subject to the following two conditions:

1. This device may not cause harmful interference, and
2. This device must accept any interference received, including interference that may cause undesired operation.

IMPORTANT NOTE

FCC Radiation Exposure Statement:

This equipment complies with FCC radiation exposure limits set forth for an uncontrolled environment. This equipment should be installed and operated with minimum distance 20cm between the radiator & your body.

This transmitter must not be co-located or operating in conjunction with any other antenna or transmitter.

Industry Canada Statement

This device complies with RSS-210 of the Industry Canada Rules. Operation is subject to the following two conditions:

1. This device may not cause harmful interference, and
2. This device must accept any interference received, including interference that may cause undesired operation.

About This Document

Purpose

This guide describes the concepts and tasks necessary to use and configure your Cisco SPA525G IP Phone.



NOTE The SPA525G features vary, depending on the type of call control system that you are using. **This document describes using the SPA525G with a SIP phone system, such as the Cisco SPA9000 Voice System or a Broadsoft or Asterisk system.** If you are using the SPA525G with a Cisco Unified Communications 500 Series, see the *Cisco Unified Communications Manager Express for Cisco Small Business Pro IP Phone SPA525G User Guide*.

Organization

This table describes the contents of each chapter in this document.

Chapter	Title	Description
Chapter 1	Getting Started	Provides an overview of the SPA525G IP phone.
Chapter 2	Installing Your Phone	Connecting your hardware and the SPA525G phone to the network.
Chapter 3	Using Basic Phone Functions	Performing basic phone functions, such as making, transferring, forwarding, and parking calls, creating conference calls, and using the phone directory and call history lists.
Chapter 4	Using Advanced Phone Features	Configuring advanced features on your phone, such as privacy and security features, speed dials, and ring tones.

Chapter	Title	Description
Chapter 5	Using the Web Interface	Accessing the web user interface for your phone to configure your address book, speed dials, and other phone features.
Chapter 6	Using the SPA932 Attendant Console	Installing and using the SPA932 Attendant Console.
Appendix A	Additional Information	Additional information for your product.
Appendix B	Where to Go From Here	Provides URLs for related product documentation and resources available on Cisco.com.

Finding Information in PDF Files

The <Product Name> documents are published as PDF files. The PDF Find/Search tool within Adobe® Reader® lets you find information quickly and easily online. You can perform the following tasks:

- Search an individual PDF file.
- Search multiple PDF files at once (for example, all PDFs in a specific folder or disk drive).
- Perform advanced searches.

Finding Text in a PDF

Follow this procedure to find text in a PDF file.

STEP 1 Enter your search terms in the Find text box on the toolbar.



NOTE By default, the Find tool is available at the right end of the Acrobat toolbar. If the Find tool does not appear, choose **Edit > Find**.



-
- STEP 2** Optionally, click the arrow next to the Find text box to refine your search by choosing special options such as Whole Words Only.
 - STEP 3** Press **Enter**.
 - STEP 4** Acrobat displays the first instance of the search term.
 - STEP 5** Press **Enter** again to continue to more instances of the term.
-

Finding Text in Multiple PDF Files

The *Search* window lets you search for terms in multiple PDF files that are stored on your PC or local network. The PDF files do not need to be open.

- STEP 1** Start Acrobat Professional or Adobe Reader.
- STEP 2** Choose **Edit > Search**, or click the arrow next to the *Find* box and then choose **Open Full Acrobat Search**.

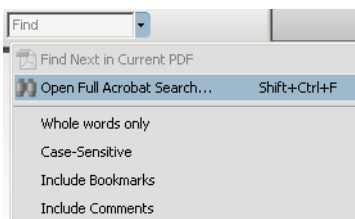

- STEP 3** In the *Search* window, complete the following steps:
 - a. Enter the text that you want to find.
 - b. Choose **All PDF Documents in**.
From the drop-down box, choose **Browse for Location**. Then choose the location on your computer or local network, and click **OK**.
 - c. If you want to specify additional search criteria, click **Use Advanced Search Options**, and choose the options you want.
 - d. Click **Search**.

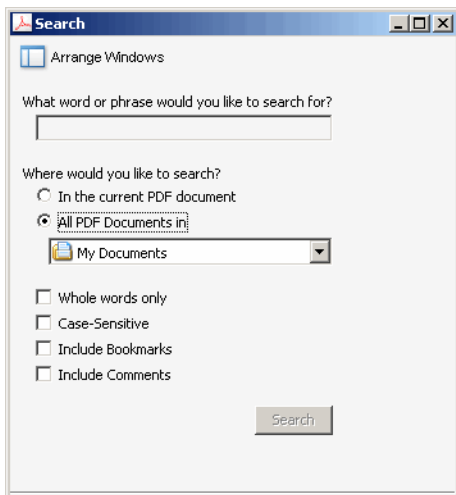

STEP 4 When the Results appear, click + to open a folder, and then click any link to open the file where the search terms appear.

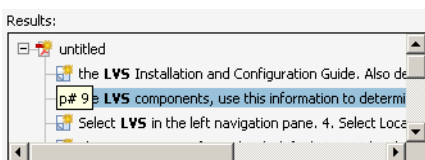

For more information about the Find and Search functions, see the Adobe Acrobat online help.

Getting Started

This chapter provides an overview of your SPA525G IP phone. contains the following sections:

- [Overview of the Cisco SPA525G IP Phone, page 14](#)
- [Understanding Your Phone's Lines and Buttons, page 16](#)
- [Using the Keypad and Buttons with Menus, page 21](#)
- [Entering Numbers and Text in Fields, page 22](#)
- [Using Phone Hardware and Accessories, page 23](#)



NOTE The SPA525G features vary, depending on the type of call control system you are using. **This document describes using the SPA525G with a SIP phone system, such as the Cisco SPA9000 Voice System or a Broadsoft or Asterisk system.** If you are using the SPA525G with a Cisco Unified Communications 500 Series, see the *Cisco Unified Communications Manager Express for Cisco Small Business Pro IP Phone SPA525G User Guide*.

Overview of the Cisco SPA525G IP Phone



The Cisco SPA525G IP Phone is a full-featured VoIP (Voice over Internet Protocol) phone that provides voice communication over an IP network. It provides traditional features, such as call forwarding, redialing, speed dialing, transferring calls, conference calling and accessing voice mail. Calls can be made or received with a handset, headset or speaker.

The SPA525G phone is connected to the network through its Ethernet connection or the built-in Wireless-G connection. If you are using the Wireless-G connection, a separate power adapter (PA-100) is required. The SPA525G provides an additional Ethernet port that allows a computer to be connected to the network through the IP phone. (This option is only available when phone is connected to the network via the wired Ethernet connection).

Unlike traditional phones, the Cisco SPA525G requires a separate power source. Either connect your phone to an Ethernet switch that provides Power over Ethernet (PoE), or use a separate power adapter (PA-100).

The SPA525G has a 320 x 240 color, 3.2" inch LCD screen and provides up to five telephone extensions. It provides the following hardware features:

- 2 Ethernet 10/100 Mbps ports
- 802.3af Power over Ethernet support
- USB 2.0 host port for connecting a USB memory device to play MP3 music files
- AUX port (to attach a SPA932 attendant console)
- Bluetooth capability for headset support
- 2.5mm stereo earphone jack for headset
- Wireless-G client support
- Kensington security slot support

Caring for Your Phone

The Cisco Small Business Pro IP phones are electronic devices that should not be exposed to excessive heat, sun, cold or water. To clean the equipment, use a slightly moistened paper or cloth towel. Do not spray or pour cleaning solution directly onto the hardware unit.

Understanding Your Phone's Lines and Buttons

Use the following graphic and table to identify the parts of your phone.

Phone Components



Figure 1 SPA525G Phone Components

Table 1 IP Phone Components

#	Phone Feature	Description
1	Handset	Pick up to answer or place calls.
2	Speaker	Speaker for phone.
3	Message Waiting Indicator	When lit: <ul style="list-style-type: none"> ▪ Red—You have a new voice mail message. ▪ Flashing Red—You have an incoming call.

Table 1 IP Phone Components

#	Phone Feature	Description
4	LCD Screen	Your phone may vary, but typically displays: <ul style="list-style-type: none"> ▪ Date and time ▪ Phone station name ▪ Line extensions ▪ Softkey options ▪ Startup logo, screen saver, background photo, and photo album
5	Line keys	Indicates phone line status. Your phone may vary, but typically, when lit: <ul style="list-style-type: none"> ▪ Green: Line is idle. ▪ Red (steady): Line is active or in use. ▪ Red (blinking): Line is on hold. ▪ Orange: Line is unregistered (cannot be used). ▪ Flashing Orange: The phone is not connected to the network.
6	Softkey buttons	Press a softkey button to perform the action on the label on the LCD screen above.
7	Navigation button	Press in each direction to scroll through items on the LCD screen.
8	Center Select button	Press this button to select the option or menu that is highlighted on the screen.
9	Messages button	Press to access voice mail (must be set up by your phone administrator).
10	Hold button	Press to place a call on hold.
11	Setup button	Press to access the phone's configuration menu to configure features and preferences (such as your directory and speed dials), access your call history, and set up functions (such as call forwarding).
12	Mute button	Press to mute or unmute the phone. When the phone is muted, the button glows red. A flashing red mute button indicates that the phone has no network connectivity.

Table 1 IP Phone Components

#	Phone Feature	Description
13	Volume button	Press + to increase the volume and press - to lower the volume of the handset, headset, speaker (when the handset is off hook), or ringer (when the handset is on hook).
14	Headset button	Press to turn the headset on or off. When the headset is on, the button glows green.
15	Speaker button	Press to turn the speaker on or off. When the speaker is on, the button glows green.
16	Keypad	Press keys to dial phone numbers, enter letters, and choose menu items.

Softkey Buttons

The four softkey buttons have different functions depending on the phone screen or menu that is shown. The following table shows the SPA525G softkey buttons that are available (in alphabetical order).

Table 2 SPA525G Softkey Buttons

Button	Function
Add	Adds a new item (for example, a new directory entry).
AddList	Creates a list (for example, of MP3 files to play).
Back	Returns you to the previous screen.
BXfer	Performs a blind call transfer. See “Performing an Unattended (Blind) Transfer,” on page 48.
Call Rtn	Returns the last missed call by dialing the number that called you. See “Viewing and Returning Missed Calls,” on page 49.
Clear	Deletes an entire text/number field.
Clr DND	Clears Do Not Disturb.
Conf	Initiates a conference call. See “Placing a Three-Way Conference Call,” on page 56.
ConfLx	Conferences existing active calls on the phone together.

Table 2 SPA525G Softkey Buttons

Button	Function
Connect	Connects to the selected item (for example, to the wireless network or Bluetooth device).
Copy	Copies the selected item (for example, a contact in the Address Book).
delChar	Deletes the last number or letter.
Delete	Deletes an entire item (for example, a number from the Call History list).
Dial	Dials the string of numbers that you have entered, or the number that you have highlighted in a list such as the Missed Calls screen.
Directory	Access your personal address book. See “Using Your Personal Address Book,” on page 57.
DND	Do Not Disturb; prevents incoming calls from ringing your phone. See “Setting Do Not Disturb,” on page 52.
Edit	Opens an item so that you can edit numbers or letters, or enable or disable a feature.
EditDial	Edits a number before dialing.
End Call	Disconnects a call.
Forward	Forwards calls coming to your phone. See “Forwarding Calls,” on page 50.
List	In some menus, shows a list of configured items (for example, a list of locations for weather or news).
GrPickup	Allows you to pick up (answer) a call at that is ringing at another extension in your group. See “Picking Up a Call,” on page 54.
Hold	Places a call on hold. See “Putting a Call on Hold,” on page 46.
More	Access additional softkeys.
Next	Moves to the next item in a list (for example, a song in the MP3 Playlist).
Option	Enters a sub-menu.
Paste	Pastes the item you copied into a list or field.
Pickup	Allows you to pick up (answer) a call that is ringing at another extension. See “Picking Up a Call,” on page 54.

Table 2 SPA525G Softkey Buttons

Button	Function
Play	Plays a selected item such as a song or a ringtone.
Previous	Moves to a previous item in a list (for example, a song in the MP3 Playlist).
Redial	Brings up the list of recently dialed numbers. See “Redialing,” on page 48.
Refresh	Refreshes the screen. Useful after changing a configuration or when you want to update information (such as weather).
Park	Parks a call at a designated “park” number. The call is active until you unpark it, or the caller disconnects. See “Parking a Call,” on page 55.
Play	Plays an item (for example, a ring tone).
Resume	Resumes a call that is on hold.
Save	Saves your changes.
Scan	Scans for wireless networks or Bluetooth devices.
Select	Selects the highlighted item on the LCD screen.
Transfer	Performs a call transfer. See “Transferring Calls,” on page 47.
Unpark	Connects to a parked call. See “Parking a Call,” on page 55.
View	Displays more information about a selected item.
XferLX	Transfers existing active calls on the phone.

Using the Keypad and Buttons with Menus

You press a softkey button or other buttons to enter menus on the LCD screen.

Using Keypad Shortcuts

Use the keypad to enter the number of the menu or sub-menu item. For example, to reach the Call History menu, press the **Setup** button and press **2**.

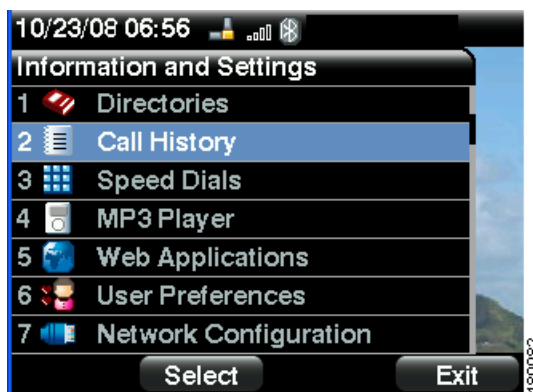

NOTE Menus and options can change depending on the software release.

Using the Navigation Button

Use the navigation button to scroll up or down through the menu items, and then press the **Select** softkey button or the center **Select** button to choose the highlighted item.

Entering Numbers and Text in Fields

Some fields on the IP phones require you to enter numbers and text using the keypad and/or softkey buttons. In general, the following guidelines apply:

- Use the keypad to enter numbers and characters, pressing the key multiple times to select the correct number or letter.
- Press the number key multiple times to move to a different letter under that number. (For example, to enter “Mary,” you would press **6** five times rapidly and then pause (for M); press **2** and then pause (for A), press **7** three times rapidly (for r), then press **9** three times rapidly (for y).

Available characters are shown in the following table:

Key	Character Set
1	1 / : \ , ! ; \$ ^
2	abc2ABC
3	def3DEF
4	ghi4GHI
5	jkl5JKL
6	mno6MNO
7	pqrs7PQRS
8	tuv8TUV
9	wxyz9WXYZ
0	Space 0 ~ ? > ' < “
*	. @ * & % [] _
#/P	# + - = () { }

Use the **delChar** softkey button to backspace and delete the last character.

Use the **Option > Clear** softkey button to remove the entire entry.

Using Phone Hardware and Accessories

Using the Speakerphone

The SPA IP Phones provide a speakerphone. To use the speakerphone, press the **Speaker** button (the handset can be either on or off hook).

Using Wired and Wireless Headsets

The SPA IP Phones support headsets from different manufacturers. For the latest supported models, contact your reseller. Additional information can be found at the manufacturer's websites:

<http://www.plantronics.com>

<http://www.jabra.com>

Connecting the Headset

Each brand and type of headset may require different steps for connection. Consult the documentation for your particular headset for more information. In general, to connect a headset:

- For Bluetooth headsets: See the "**Connecting Bluetooth Headsets**" section on **page 24**.
- For wireless, non-Bluetooth headsets (such as Plantronics or Jabra): Connect the headset's telephone cord into the telephone port on the back of the SPA IP Phone.

- For wired headsets: Connect the 2.5mm connector from the headset into the headset port on the right side of the IP phone as shown in the following graphic:



Connecting Bluetooth Headsets

Your phone is Bluetooth compatible and works with Bluetooth devices such as headsets.

To configure the phone to work with your headset, first enable Bluetooth:

-
- STEP 1** Press the **Setup** button.
 - STEP 2** Select **User Preferences**.
 - STEP 3** Select **Bluetooth Configuration**.
 - STEP 4** With **Bluetooth** selected, press the **Right Arrow** key to turn Bluetooth *On*.
 - STEP 5** Press **Save**.
-

After enabling Bluetooth, create a profile for your headset:

-
- STEP 1** In the Bluetooth Configuration screen, scroll to **Bluetooth Profiles**. Press the **Right Arrow** key to enter the profile screen.
 - STEP 2** Press **Scan** to scan for your headset.
 - STEP 3** In the list of found devices, select your headset and press the **Select** button to edit the profile.

-
- STEP 4** Scroll to **PIN** and enter the PIN for your Bluetooth headset.
 - STEP 5** Scroll to **Connect Automatically** and press the **Right Arrow** key to turn to *On*.
 - STEP 6** Press **Connect**. The profile screen displays and a check mark appears next to the headset if the connection was successful.
-

Using a Headset with Your IP Phone



NOTE: Steps to use your headset with the SPA IP Phone may vary. Consult the user documentation for your headset for more information.

- To use a wired headset, press the **Headset** button on your phone and dial the number to place a call, or press the headset button to answer a ringing call.
- To use a non-Bluetooth wireless headset (such as Jabra or Plantronics), lift the receiver off hook before speaking or listening through the headset.
- To use a Bluetooth headset, make sure your headset is powered on. Press the **Headset** button on your phone (or, if supported, press the **Answer** button on your Bluetooth headset twice) and dial the number to place a call. Press the **Answer** button on your Bluetooth headset to answer a ringing call. See the user documentation for your Bluetooth headset for more information.

Switching Between the Handset/Headset/Speakerphone During a Call

Any of these audio devices can be used during a call. Only one device can be used at a time. The handset can be on the hook when using the speakerphone or headset function.

To switch from the handset to the speakerphone, press the **Speakerphone** button and place the handset back on the hook.

To switch from the speakerphone to a headset, press the **Headset** button.

To switch from the speakerphone to the handset, pick up the handset.

To switch from the headset to the speakerphone, press the **Speakerphone** button.

Installing Your Phone

This chapter describes how to install and connect your Cisco SPA525G IP Phone. It contains the following sections:

- [Before You Begin, page 28](#)
- [Connecting the Handset, page 28](#)
- [\(Optional\) Attaching the Desk Stand, page 30](#)
- [\(Optional\) Mounting the Phone to the Wall, page 31](#)
- [Connecting Your Phone's Power, page 33](#)
- [Connecting Your Phone to the Computer Network, page 34](#)
- [Verifying Phone Startup, page 42](#)
- [Upgrading Your Phone's Firmware, page 42](#)

Before You Begin

Before you install and connect your phone, verify with your System Administrator (if applicable) that the network is ready for the phone, read the safety notices, and make sure you have all the phone parts and documentation available.



NOTE: The RJ-11 port marked “AUX” is reserved for connection with the SPA932 Attendant Console that works with the SPA525G. It is not for use as a telephone line port.



CAUTION: Do not plug a telephone line cord into the port marked “AUX.”

Connecting the Handset

-
- STEP 1** Find the longer end of the coiled phone cord. Insert it into the back of the phone base in the slot marked with a phone symbol. This port is labeled #5 on the [Cisco SPA525G IP Phone Connections](#) graphic.
- STEP 2** Insert the short end of the handset cord into the jack at the bottom of the handset (not shown).
-

Figure 1 Cisco SPA525G IP Phone Connections



Number	Component
1	Auxiliary port. Only for use with the SPA932 attendant console.
2	Power port. Insert the power adapter plug into this port.
3	Additional Ethernet port. Connect an Ethernet cable to this port to provide network connectivity to a PC. (This port cannot be used when the phone is connected to the network via the built-in Wireless-G client.)
4	Switch (Ethernet) port. Connect the network cable to this port.
5	Phone cord slot. Insert one end of the phone cord into this slot and the other into the jack at the bottom of the phone handset.
6	USB port. For use with an external USB memory device (optional).

(Optional) Attaching the Desk Stand



NOTE: Do not attach the desk stand if you want to mount the phone to the wall. If you are attaching a SPA932 attendant console attach the console before attaching the desk stand.

-
- STEP 1** Line up the tabs on the desk stand with the slots on the back of the phone.
 - STEP 2** Slide the bottom tabs into the slots
 - STEP 3** Lightly press down on the top of the desk stand. It should easily slide into the top slots. Do not force.
-

(Optional) Mounting the Phone to the Wall

To mount the phone to the wall, you must purchase the MB100 wall mount bracket kit.

Figure 2 MB100 Wall Mount Kit



- STEP 1** To attach the Mounting Bracket (MB), align the two cleats on the MB with the holes in the phone's base.

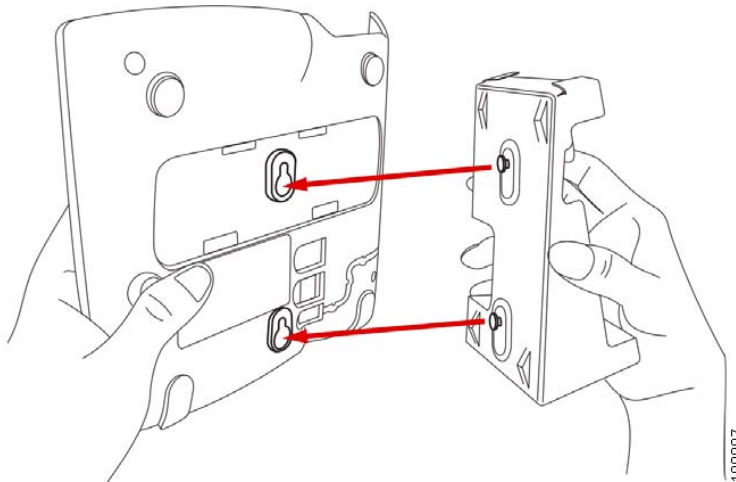

- STEP 2** Orient the MB such that the phone's Ethernet and handset ports are accessible after installation.

STEP 3 Push the MB onto the phone's base. Slide the MB upwards to lock it in place.

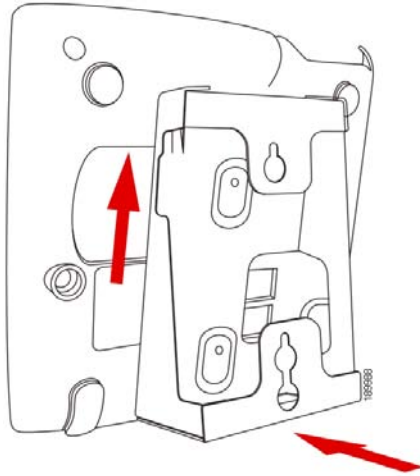

STEP 4 Plug in the Ethernet and power cables.

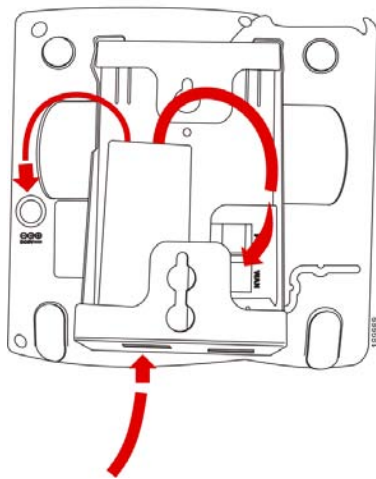

STEP 5 Hang onto screws mounted in the wall.

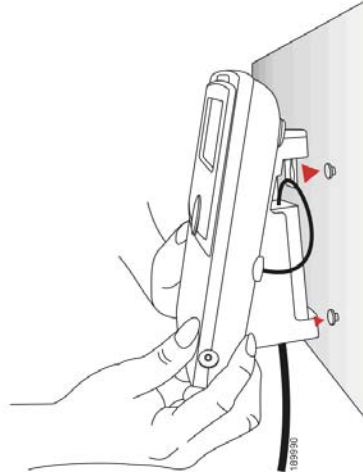

Connecting Your Phone's Power

If you are using an external power source, plug it into the building's power source, and plug the power supply into the phone base. See [Figure 1 on page 29](#), item #2.



NOTE: The SPA525G does not ship with a power supply. If you are not using Power over Ethernet (PoE), you must order the PA-100 power supply separately from Cisco.

If you are using Power over Ethernet (PoE) to power the phone, the phone will receive power when you connect an Ethernet cable from the phone's WAN port to a switch in your network that provides PoE. See the "[Connecting Your Phone to the Wired Network](#)" section on page 34.

Connecting Your Phone to the Computer Network

Connecting Your Phone to the Wired Network

You connect your phone to the local network by using an Ethernet cable:

- STEP 1** Plug the Ethernet cable into the back of the base station into the slot marked “SW.” This port is labeled #4 on [Figure 1 on page 29](#).
- STEP 2** Plug the other end of the Ethernet cable into the appropriate device on your network, such as a network switch.



NOTE: The SPA525G provides a second Ethernet port. You can connect a PC to this port to provide network access to the PC. This port is labeled #3 in the [Cisco SPA525G IP Phone Connections](#) graphic. This port cannot be used when the phone is connected to the network via the built-in Wireless-G client.

Connecting Your Phone to the Wireless Network



NOTE The PC port is not supported in wireless operation. The PC port is only supported in a wired operation.

The Cisco SPA 525G phone supports a direct connection to the wireless network. Before setting up the wireless network, you need to know the wireless security type for your router. The SPA525G works with the following security types:

- **WEP—Wired Equivalent Privacy.** With this type of security, you need to enter a 64 or 128-bit key on the phone (or a more easily remembered passphrase to generate the key). The phone then authenticates with your router to provide a secure connection.
- **WPA—Wi-Fi Protected Access.** The SPA525G supports WPA PSK, WPA2 PSK, WPA Enterprise, and WPA2 Enterprise. With this type of security, you will at the very minimum be required to enter a password on the phone. The phone then authenticates with your router to provide a secure connection.

Determining Your Wireless Router Security Type

If you do not know your wireless router security type, you need to log in to the router interface to get this information. The steps below are written for a Linksys router, but procedures for other routers should be similar.

-
- STEP 1** Log in to your wireless router's web interface using a web browser. Your computer must be connected to your wireless network. Enter the IP address of the wireless router in the browser toolbar.
 - STEP 2** If required, enter the user name and password. (By default, Linksys routers typically use "admin" for the user name and "admin" for the password.)
 - STEP 3** View the Wireless tab or screen. Note the network name (SSID) and the type of security (WEP, WPA Personal, or WPA2 Personal).

If your router is using WEP, note the following:

- **WEP encryption:** 64 bit or 128 bit. You need to choose this later.
- **Default transmit key, or TX key:** The default key (of the 4) that the router transmits to authenticate. This value will be 1, 2, 3, or 4.
- **Passphrase and keys:** You choose one of two methods to enter the WEP key. You either directly enter the WEP key, or enter a more simple passphrase to generate the WEP key.

The following example shows WEP information for a Linksys WRV200 router:

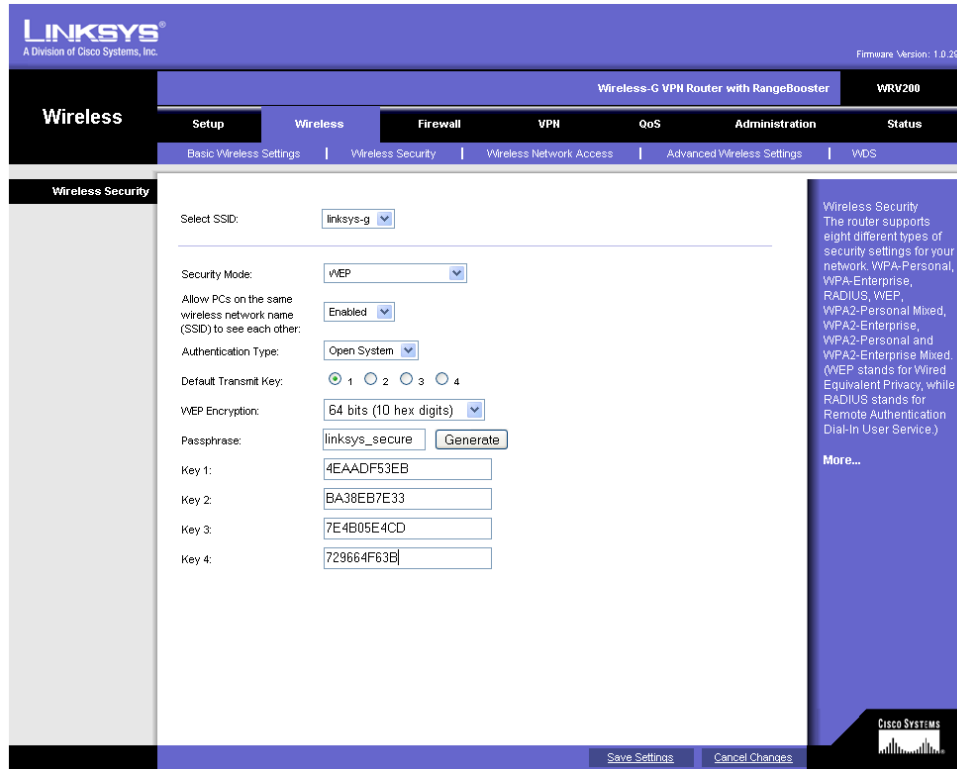

If your router is using WPA, note the WPA shared key, or passphrase that you need to enter later.

The following example shows WPA information for a Linksys WRT160N router:

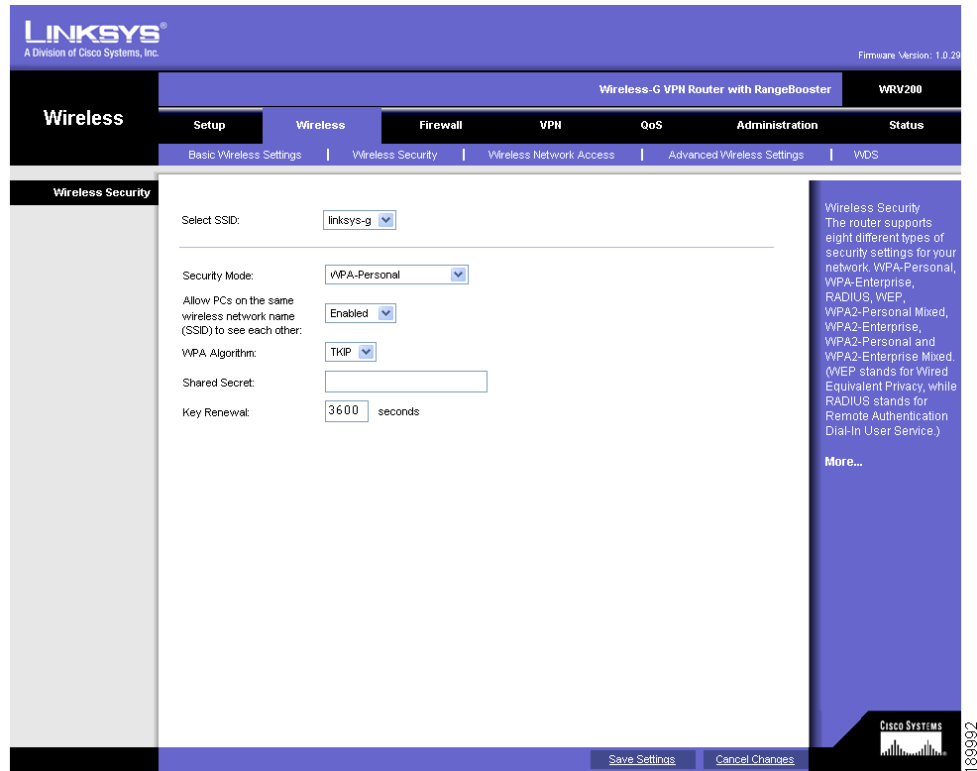

To set up the SPA525G wireless connection:

- STEP 1** If you have plugged in an Ethernet cable to connect the phone to the wired network, remove it and reboot the phone. If an Ethernet connection is present on the phone, it is used instead of the Wi-Fi connection.
- STEP 2** Press the **Setup** button on your phone.
- STEP 3** Scroll to **Network Configuration** and press **Select**.
- STEP 4** In the Wi-Fi field, press the **Left** or **Right Arrow** key to turn Wi-Fi *On*. Press the **Save** softkey.

- STEP 5** Scroll to Wi-Fi Configuration and press the **Right Arrow** key. Choose one of the following options:
- **Wireless Profile**—Use this option to add a new wireless profile (either manually or by scanning for available networks), edit an existing wireless profile, or connect to a previously configured network. See [Manually Adding a Wireless Profile on the SPA525G, page 39](#).
 - **Wi-Fi Protected Setup**—If your wireless router supports Wi-Fi Protected Setup, use this method to set up your wireless connection. See [Using Wi-Fi Protected Setup with the SPA525G, page 38](#).

Using Wi-Fi Protected Setup with the SPA525G

If your router has a WPS button, you can use Wi-Fi Protected Setup to add a new wireless network profile.



STEP 1 In the Wireless Configuration screen, select *Wi-Fi Protected Setup*.

STEP 2 Choose one of the following options:

Push Button Configuration:

- a. Press the WPS button on your router.
- b. On your phone, with *Push Button Configuration* highlighted, press **Select**. Your phone may reboot before the Wi-Fi connection is working.

PIN Configuration

- a. After selecting **PIN Configuration** on your phone, note the PIN displayed.
- b. Connect to your router's web interface using a web browser. Your computer must be connected to your wireless network. Enter the IP address of the wireless router in the browser address bar.
- c. If required, enter the user name and password. (By default, Linksys routers typically use "admin" for the user name and "admin" for the password.)
- d. View the Wireless tab or screen. Locate the Wireless Protected Setup configuration menu.

- e. Enter the PIN into the field that allows you to setup wireless devices using a PIN.
- f. Save your changes.
- g. On the SPA525G, with PIN Configuration highlighted, press **Select**. To add the connection as a profile, press **OK**. Your phone may reboot before the Wi-Fi connection is working.

Manually Adding a Wireless Profile on the SPA525G

To add a new wireless network profile:

-
- STEP 1** In the Network Configuration screen, ensure Wi-Fi is enabled.
 - STEP 2** Scroll to *Wi-Fi Configuration*. Press the **Right Arrow** key to enter the Wi-Fi Configuration screen.
 - STEP 3** Select **Wireless Profile**. Any previously configured wireless profiles are displayed.
 - STEP 4** Do one of the following:
 - Scan for available networks. See [Scanning for Available Networks, page 39](#).
 - Manually add the network. See [Manually Adding a Network, page 40](#).

Scanning for Available Networks



NOTE If your router has SSID (router name) broadcast disabled, it may not appear in the list of networks. In that case, you need to manually add it (see [Manually Adding a Network, page 40](#)).

-
- STEP 1** In the Wireless Profile screen, press **Scan**.
 - STEP 2** In the list of available networks, scroll to the desired network and click **Add** to select the highlighted network.

STEP 3 (Optional) Press the **Right Arrow** key under Security Mode to set the security options:

- WEP—Wired Equivalent Privacy: You must enter the Default Transmit Key, Key Type and Length, and the keys.
- WPA PSK or WPA2 PSK: You must enter the Cipher Type (TKIP or AES CCMP) and the shared key.
- WPA/WPA2 Enterprise: This type of authentication requires some advanced expertise because it involves setting up a radius server for authentication and, in some cases, creation of certificates for both the radius server and the phone. See

You must enter the Cipher Type (TKIP or AES CCMP) and the EAP Type:

- TTLS—Enter the anonymous ID, choose whether the phone should check for the server certificate, choose the TTLS Inner Protocol (MSCHV2, MSCHAP, PAP, CHAP, or MD5), and enter the User ID and password.
- LEAP—Enter the User ID and password.
- TLS—Enter the User ID, choose whether the phone should check for the server certificate, enter the User ID, and configure the Root certificate and User certificate (see the ["Uploading Security Certificates to the Phone" section on page 41](#)).

STEP 4 To save as a wireless profile, press **Save**.

Manually Adding a Network

STEP 1 From the Wireless Profile screen, press **Option** and select **Add New** to manually add the network.

STEP 2 (Optional) Press the **Right Arrow** key under Security Mode to set the security options:

- WEP—Wired Equivalent Privacy: You must enter the Default Transmit Key, Key Type and Length, and the keys.
- WPA PSK or WPA2 PSK: You must enter the Cipher Type (TKIP or AES CCMP) and the shared key.

- WPA/WPA2 Enterprise: You must enter the Cipher Type (TKIP or AES CCMP) and the EAP Type:
 - TTLS: Enter the anonymous ID, choose whether the phone should check for the server certificate, choose the TTLS Inner Protocol (MSCHV2, MSCHAP, PAP, CHAP, or MD5), and enter the User ID and password.
 - LEAP: Enter the User ID and password.
 - TLS: Enter the User ID, choose whether the phone should check for the server certificate, enter the User ID, and configure the Root certificate and User certificate (see the ["Uploading Security Certificates to the Phone" section on page 41](#)).

STEP 3 To save as a wireless profile, press **Save**.

Uploading Security Certificates to the Phone

If you are using some types of wireless security (for example, WPA2 Enterprise), you will need to upload security certificates to the phone. Certificates must be in the following format:

- Root certificate: DER encoded binary x.509 (CER)
 - User certificate: Personal Information Exchange (PKCS# 12(.PFX))
-

STEP 1 Connect a USB storage device to your PC.

STEP 2 Create a directory named **"ca"** on the USB device and copy the certificate files into that directory.

STEP 3 Remove the USB device from your PC and insert it into the USB slot on the SPA525G.

STEP 4 After creating a wireless profile, in the Profile screen, press the **Right Arrow** key under Security Mode to set the security options (WPA Enterprise or WPA2 Enterprise).

STEP 5 Scroll to **Root Certificate** and press the **Right Arrow** key. All files in the **"ca"** folder are displayed.

STEP 6 Use the **Up Arrow** or **Down Arrow** key to choose the certificate you want to install (for example, the root certificate). Press the **Select** softkey.

STEP 7 Press **Save** to save the profile.

Verifying Phone Startup

After receiving power and network connectivity, the phone executes a boot-up sequence. During this sequence, the display shows the Cisco logo. All of the lights on the phone will flash. After the sequence, which should take about five seconds, the phone will display the standard menu for the phone. The date, name and number of the phone appear on the top line of the LCD screen. At the bottom of the LCD screen, softkeys appear over their associated soft buttons.

If the phone does not display this screen, confirm your installation and connections. If these are correct, try unplugging the phone and plugging it back in again. If you still don't see the display, then contact your Phone Administrator or Internet Telephony Service Provider (ITSP).

Upgrading Your Phone's Firmware

Your phone ships with pre-installed firmware. However, later firmware versions may be available that add features and fix problems with your phone. You may need to upgrade your phone to the latest firmware for ideal performance.



IMPORTANT: If you are using your phone with an Internet Telephony Service Provider's system, **do not upgrade your phone's firmware without consulting your service provider.** Your provider may automatically upgrade your phones without any action on your part necessary.

There are two ways to upgrade your phone's firmware:

- Download the firmware to your PC and log in to the web interface to run the upgrade procedure. See the ["Upgrading Firmware" section on page 94](#).
 - Upgrade using the Cisco SPA9000 Voice System Setup Wizard (if your phone is part of a Cisco SPA9000 Voice System network). See the *Cisco SPA9000 Voice System Setup Wizard User Guide*.
-

Using Basic Phone Functions

This chapter describes how to use the basic functions of your SPA525G IP phone. It includes the following sections:

- [Placing or Answering a Call, page 45](#)
- [Adjusting Call Volume and Muting, page 46](#)
- [Putting a Call on Hold, page 46](#)
- [Resuming a Call, page 47](#)
- [Ending a Call, page 47](#)
- [Transferring Calls, page 47](#)
- [Redialing, page 48](#)
- [Viewing and Returning Missed Calls, page 49](#)
- [Turning the Missed Calls Shortcut On and Off, page 50](#)
- [Forwarding Calls, page 50](#)
- [Setting Do Not Disturb, page 52](#)
- [Picking Up a Call, page 54](#)
- [Parking a Call, page 55](#)
- [Placing a Three-Way Conference Call, page 56](#)
- [Using the Phone Directories, page 57](#)
- [Using the Call History Lists, page 61](#)
- [Setting or Changing a Phone Password, page 63](#)
- [Accessing Voicemail, page 64](#)

Placing or Answering a Call



NOTE: You may have to dial a number or numbers to reach an outside line. Ask your system administrator.

To place or answer a call, do one of these:

- Pick up the receiver.
- Press the **Speaker** button.
- Press the **Headset** button.
- Press a green line button (to place a call) or a red flashing line button or the **Answer** softkey (to answer a call).

If you are on a call and another call comes in, choose one of the following options:

- Press the **Answer** softkey.
- Press the flashing red line button.

The call in progress is put on hold and the incoming call is answered.

To return to the first call, select it using the **Up Arrow** or **Down Arrow** key and press the **Resume** softkey.

Using Dial Assistance

If dial assistance is enabled, when placing calls, you'll see a list of closely-matched phone numbers on the screen after you begin dialing. If you want to choose one of these numbers:

STEP 1 Use the navigation button to scroll down and highlight a phone number on the LCD screen.

STEP 2 Press the **Select** button or **Dial** to complete the call.

See “[Enabling Dial Assistance](#),” on page 68 for more information on enabling this feature.

Adjusting Call Volume and Muting

Adjusting Call Volume

To adjust the volume while you are on a call, press **+** on the **Volume** button to increase the volume, or press **-** to decrease the volume. Press **Save**.

Pressing the **Volume** button while not on a call adjusts the volume of the phone's ringer.

Using Mute

To mute the phone microphone, speaker, or headset microphone, press the **Mute** button on the phone. The button lights red. Press the **Mute** button again to unmute.

Putting a Call on Hold

To put a call on hold, press the **Hold** button. A series of beeps indicates the call is on hold.

Resuming a Call

To resume the call, press the flashing red line button for the call. If you have multiple calls, all calls are put on hold except the active call.

Ending a Call

To end a call:

- If you are using the handset, hang up.
- If you are using the speakerphone, press the **Speaker** button.
- If you are using the headset, either press the **Headset** button (wired) or replace the receiver (wireless).

Transferring Calls

You can perform two types of transfers:

- **Attended**—You call the person to whom you are transferring the call and speak to them before transferring the call.
- **Blind**—You transfer the call without speaking to the other party to which you are transferring the call.

Performing an Attended Transfer

-
- STEP 1** During an active call, or a call on hold, press **Transfer**.
- STEP 2** Either:
- Enter the number to which you want to transfer the call; or
 - Press **Directory** and either choose a number from the personal directory.
- STEP 3** Press **Dial** or wait a few seconds. The call is placed on hold and a new line is opened to dial the number.

STEP 4 Do one of the following:

- To transfer the call without waiting for the other person to answer, press **Transfer** after the call begins to ring and hang up. If you hang up before the second call rings, the transfer fails and the first call is disconnected. If you misdial, press the second line button again to receive a dial tone.
 - To transfer after speaking privately to the other person, press **Transfer** at any time during the conversation.
-

Performing an Unattended (Blind) Transfer

STEP 1 During an active call, press **BXfer**.

STEP 2 Enter the number to which you want to transfer the call and press **Dial**. The call is transferred with no further action required on your part.

Redialing

To redial a number:

STEP 1 Press the **Redial** button and select the desired number.

STEP 2 (Optional) Press **EditDial** to select a number and modify it (for example, to add an area code).

STEP 3 Lift the handset or press **Dial** to select a number. The number is automatically dialed.

Viewing and Returning Missed Calls

The LCD screen on your IP phone notifies you if a call came in that was unanswered. (You can also turn off this feature - see the "Turning the Missed Calls Shortcut On and Off" section on page 50.)

Returning a Missed Call

To return a missed call:

- If the LCD screen shows a missed call, press the **Call Rtn** button to return the call.
- If the LCD screen does not show a missed call, you can return a call from the Missed Call list. See "Viewing a List of Missed Calls" on page 49. Choose the call you want to return and press **Dial**.



NOTE: If the call was from a long distance number, you may have to edit the call before returning it. Press the **Edit** button to edit the call and use the softkey buttons and keypad to edit the number.

Viewing a List of Missed Calls

To view a list of all missed calls:

- If the LCD screen shows a missed call, press the **Missed** softkey to view a list of missed calls.
- If the LCD screen does not show a missed call:
 - a. Press the **Setup** button.
 - b. Scroll to **Call History** and press **Select**.

- c. Scroll to **Missed Calls** and press **Select**. You can do one of the following:
 - Press **Dial** to dial the number that called you.
 - Press **EditDial** to edit the number before calling it, then press **Dial**.
 - Press the **Option** softkey and choose one of the following:
 - **Delete Entry**—Delete the entry from the Missed Calls list.
 - **Delete List**—Delete all entries from the Missed Calls list.
 - **Add to Address Book**—Add the entry to your personal address book.

Turning the Missed Calls Shortcut On and Off

This option controls the Missed Call notification that appears on your LCD screen when you miss a call. To access this option:

-
- STEP 1** Press the **Setup** button.
 - STEP 2** Scroll to **User Preferences** and press **Select**.
 - STEP 3** Select **Call Preferences**.
 - STEP 4** Scroll to **Miss Call Shortcut**.
 - STEP 5** Press the **Right Arrow** key to turn the feature on and press the **Save** softkey.
-

Forwarding Calls

You can forward all calls, forward calls when the phone is busy or forward calls when there is no answer. You can also set call forwarding options from your PC using the IP Phone Web Interface; see the ["Configuring Call Forwarding" section on page 89](#).

To forward calls:

-
- STEP 1** Press the **Setup** button.
 - STEP 2** Scroll to **User Preferences** and press **Select**.

STEP 3 Select **Call Preferences**.

STEP 4 Under *Call Forwarding*, press the **Right Arrow** key to turn call forwarding on and press the **Save** softkey.

See the following sections for information on the types of call forwarding.

Forwarding Calls to a Single Number

STEP 1 In the Call Preferences screen, scroll to **Forward All Number**.

STEP 2 Enter a number to which to forward all calls; for example, your voice mailbox, another extension, or an outside line. If forwarding calls to an outside line, be sure to enter any access and area codes required.



TIP If you need to enter a URL, press **Option** and choose **Input IP** before entering the call forwarding information.

STEP 3 Press **Save**.

Forwarding Calls When Your Phone is Busy

STEP 1 In the Call Preferences screen, scroll to **Forward Busy Number**.

STEP 2 Enter “vm” for voice mail, or a number to which to forward all calls; for example, another extension, or an outside line. If forwarding calls to an outside line, be sure to enter any access and area codes required.

STEP 3 Press **Save**.

Forwarding Calls When You Don't Answer the Phone

-
- STEP 1** In the Call Preferences screen, scroll to **Forward No Ans Number**.
 - STEP 2** Enter “vm” for voice mail, or a number to which to forward all calls; for example, another extension, or an outside line. If forwarding calls to an outside line, be sure to enter any access and area codes required.
 - STEP 3** Press **Save**.
-

Delaying Call Forwarding When You Don't Answer the Phone

-
- STEP 1** In the Call Preferences screen, scroll to **Forward No Ans Delay**.
 - STEP 2** Enter the number of seconds to delay forwarding calls, if there is no answer at your phone.
 - STEP 3** Press **Save**.
-

Stopping Call Forwarding

To stop forwarding calls:

-
- STEP 1** Under *Call Forwarding*, press the **Right Arrow** key to turn call forwarding **Off**.
 - STEP 2** Press the **Save** softkey.
-

Setting Do Not Disturb

Use the Do Not Disturb feature to prevent incoming calls from ringing your phone. If you have voice mail configured, incoming callers immediately reach voice mail. If voice mail is not configured, callers hear a busy signal or message.

You can also set Do Not Disturb from your PC using the IP Phone Web Interface; see the ["Setting Do Not Disturb" section on page 88](#).

To set Do Not Disturb, choose one of the following options:

- Press the **Do Not Disturb** softkey on your phone. The LCD screen indicates that Do Not Disturb is turned on for your phone; or
- Press the **Setup** button and select **User Preferences**. Then:

STEP 1 Choose **Call Preferences**.

STEP 2 Scroll to *Do Not Disturb*.

STEP 3 Press the **Right Arrow** key to turn Do Not Disturb on.

STEP 4 Press **Save**.

To turn off Do Not Disturb, choose one of the following options:

- Press the **Clr DND** softkey on your phone; or
- Press the **Setup** button and select **User Preferences**. Then:

STEP 1 Choose **Call Preferences**.

STEP 2 Scroll to *Do Not Disturb*.

STEP 3 Press the **Right Arrow** key to turn Do Not Disturb **Off**.

STEP 4 Press **Save**.

Configuring Call Waiting

Call waiting alerts you when you are on a call with a status message and ringing that another call is incoming. If you turn call waiting off, incoming calls do not ring your phone if you are on another call, and the caller hears a busy signal or message.

To turn call waiting on or off:

STEP 1 Press the **Setup** button.

STEP 2 Scroll to **User Preferences** and press **Select**.

STEP 3 Select **Call Preferences**.

STEP 4 Scroll to **Call Waiting** and press the **Right Arrow** key to turn call waiting **On** or **Off**.

STEP 5 Press **Save**.

Picking Up a Call

You can pick up a call that is ringing at another extension. Depending on the way your phone network is configured, you can pick up a call ringing at any extension, or you may have a group of phones configured where members of the group can pick up a call ringing at any group member's phone.

To pick up a call ringing at an extension in your group:

STEP 1 Press **GrPickup**. The phone displays any extensions in the group that have ringing calls.

STEP 2 Choose the call you want to pick up and press **Dial**.

To pick up a call ringing at any extension:

STEP 1 Press the **Pickup** button.

STEP 2 Enter the extension number of the phone from which you are picking up the call and press **Dial**.

STEP 3 Select the call from the list and press **Dial** again.

Parking a Call

You can “park” a call on a designated line so that another person in your company can pick up the call. The call is active until it is “unparked” or the caller hangs up.



NOTE Not all phone systems support call park. If this feature is not working, check with your system administrator.

To park a call:

-
- STEP 1** While on an active call, press the **Park** button.
 - STEP 2** Enter a number to identify the park line and press **Dial**. The park line number does not correspond with an actual phone extension number. You can pick any easily-remembered number. The call is then parked on that line, and the caller hears “on hold” music or messages.
 - STEP 3** You or another person must then “unpark” the call.
-

To unpark a call, you can either use the **Unpark** button (if you know the park line number), or view a list of parked calls and unpark it from the list.

To unpark if you know the park line number:

-
- STEP 1** Press the **Unpark** button.
 - STEP 2** Enter the number identifier of the park line (for example, the number that was entered in Step 2 of “parking a call.”)
 - STEP 3** Press **Dial**. The call is picked up on your phone.
-

To view a list of parked calls (and unpark from the list):

-
- STEP 1** Press the **Setup** button.
 - STEP 2** Select **Status**.
 - STEP 3** Scroll to **Call Park Status** and press **Select**.
 - STEP 4** Choose the parked call you want to retrieve and press **Unpark**.
-

Placing a Three-Way Conference Call

To initiate a conference call:

-
- STEP 1** Press the **Conf** button during an active call. The first call is placed on hold, a second line is opened, and you hear a dial tone.
 - STEP 2** Dial the second person's telephone number.
 - STEP 3** Press the **Conf** button again. All three parties are connected in the conference call.

When you hang up, the other two parties are disconnected. To keep the other parties in a call, but disconnect yourself from the call, press **Join**.

To conference two active calls on your phone:

-
- STEP 1** On one of the active calls, press **ConfLx**. If you have two active lines, the calls are conferenced. If you have more than two active lines, you must scroll to choose the line you want to conference in.
 - STEP 2** Press **Select**.
-

Using the Phone Directories

The SPA525G IP phone provides several different types of phone directories, depending on the phone model and what the system administrator has set up for the company.

In general, the phones provide the following types of directories:

- **Personal Address Book**—The personal directory provides a place for you to store and view frequently dialed numbers. You can also dial numbers from the directory.
- **Corporate Directories**—Depending on your phone network configuration, you may have one or more of the following directories available:
 - Corporate Directory (XML)
 - Corporate Directory (LVS)
 - Directory using Lightweight Directory Access Protocol (LDAP)

Using Your Personal Address Book

To access the Phone Directory, press the **Directory** button, or press the **Setup** button, select **Directories**, and select **Personal Address Book**.

You have the following options in the Address Book:

- **Options**—Press **Options** and choose one of the following:
 - **Search**—Search for a name.
 - **Delete**—Delete a contact.
 - **Copy**—Copy a contact.
 - **Paste**—Paste a contact.
 - **Edit Dial**—Edit a contact's number before dialing.
- **Dial**—Press to dial a highlighted contact.
- **Add**—Choose to add a new contact.

Use the **Down Arrow** key to scroll through entries in the address book. Use the **Right Arrow** key to scroll through the phone numbers available for the highlighted contact.

You can also view and edit the directory from your PC using the IP Phone Web Interface. See the ["Configuring Your Address Book" section on page 87](#).

Adding a New Contact

To add a new entry to the directory:

-
- STEP 1** In the Personal Address Book screen, press **Add**.
- STEP 2** Use the keypad to enter the name of the directory entry. When finished with the name, use the **Down Arrow** to navigate to the other fields.



TIP To enter numbers and letters, press **Option** and select **Input All**. To enter only numbers, press **Option** and select **Input Num**. To clear all characters from an entry, press **Option** and select **Clear**.

-
- STEP 3** Enter the office, mobile, or home phone number, including any digits you must dial to access an outside line and the appropriate area code, if necessary. You must enter at least one phone number for a contact.



TIP To enter numbers and letters, press **Option** and choose **Input All**. To enter only numbers, press **Option** and select **Input Num**. To enter an IP address, press **Option** and select **Input IP**. To enter a star code, press **Option** and select **Input Star Code**. (See ["Using Star Codes," on page 80](#).) To clear all characters from an entry, press **Option** and select **Clear**.

-
- STEP 4** (Optional) To change the ring tone for the caller:
- Press the **Right Arrow** to enter the Select Ring Tone screen.
 - Scroll through the available ring tones.
 - Press the **Play** button to play the selected ring tone or the **Select** button to assign that ringtone to the person whose number you are adding to the directory.

-
- STEP 5** Press **Save** to save the entry.
-

Copying a Contact

You can copy a contact to create a new contact, changing information as necessary on the second contact. To copy a contact:

-
- STEP 1** In the Personal Address Book screen, scroll to highlight a contact.
 - STEP 2** Press **Option** and select **Copy**.
 - STEP 3** Press **Option** again and select **Paste**.
 - STEP 4** Edit any necessary fields and press **Save**.
-

Searching for a Contact

To search for a contact:

-
- STEP 1** In the Personal Address Book screen, press **Option** and select **Search**.
 - STEP 2** Begin to enter the person's name. The list below displays entries as you type in characters. Scroll to highlight the entry you want.

You can press **Dial** to call the contact, or **Option** to delete, copy, or edit the contact.

Deleting a Contact

To delete a contact:

-
- STEP 1** In the Personal Address Book screen, highlight the contact you want to delete.
 - STEP 2** Press **Option** and select **Delete**.
 - STEP 3** Press **OK** to delete the contact.
-

Editing a Contact

To edit a contact's phone information:

STEP 1 In the Personal Address Book screen, highlight the contact you want to edit.

STEP 2 Choose one of the following:

Press the center **Select** button to choose the contact and edit the numbers in the entry. Use the **delChar** key to delete numbers individually, or press **Option** and choose **Clear** to delete all numbers and start over.

Press **Save** when finished.

Using the Corporate Directory



NOTE: Depending on your Internet Telephony Service Provider or corporate network setup, you may not have a corporate directory available to you.

To use the corporate directory:

STEP 1 Press the **Setup** button and select **Directories**.

STEP 2 Scroll to the **Corporate Directory** you want to view and press **Select**.

To use the Lightweight Directory Access Protocol (LDAP) directory:

STEP 1 Press the **Setup** button and select **Directories**.

STEP 2 Scroll to the **LDAP Directory** and press **Select**.

STEP 3 Choose the type of search to perform and press **Select**:

- **Simple Search**: Enter a last name and press **Search**. A first name may be required if too many results are found for the last name.
- **Advanced Search**: The fields available in advanced search depend on your system configuration. Enter information into the fields and press **Search**.

STEP 4 In the results, press **Dial** to dial the contact, or choose one of the other options.

Using the Call History Lists

You can also view the Call History Lists from your PC using the IP Phone Web Interface. See the "[Viewing Call History Lists](#)" section on page 91.

Viewing the Call History Lists

To view the Call History lists:

STEP 1 Press the **Setup** button.

STEP 2 Scroll to **Call History** and press **Select**.

STEP 3 Select the Call History list you want to view. Available Call History lists are:

- **All Calls**—Shows all calls placed, received, and missed on the phone.
- **Missed Calls**—Shows the last 60 missed calls.
- **Received Calls**—Shows the caller ID of the last 60 answered calls.
- **Placed Calls**—Shows all calls placed from the phone.

STEP 4 Press **Select** to view the list.

Deleting a Call History List

- STEP 1** Press the **Setup** button.
 - STEP 2** Scroll to **Call History** and press **Select**.
 - STEP 3** Scroll to the Call History list you want to delete.
 - STEP 4** Press **Option** and select **Delete List**.
 - STEP 5** Press **OK** to delete the list.
-

Calling from the Call History Lists

To dial a number from one of the Call History lists:

-
- STEP 1** Choose the call.
 - STEP 2** Press **Dial**.



NOTE If the call was from a long distance number, you may have to edit the call before dialing it. Press the **EditDial** button to edit the call and use the softkey buttons and keypad to edit the number.

Deleting an Entry from the Call History Lists

-
- STEP 1** In the call history list, choose the call.
 - STEP 2** Press **Option** and select **Delete Entry**.
 - STEP 3** Press **OK**.
-

Saving a Call History List Number to Your Directory

- STEP 1** In the call history list, choose the call.
 - STEP 2** Press **Option** and select **Add to Address Book**.
 - STEP 3** Press **Select**. The Address Book entry screen appears.
 - STEP 4** Edit the information (if desired) and press **Save** again. The entry is added to your directory.
-

Setting or Changing a Phone Password

You can set or change the password for your phone to prevent unauthorized use. To set a password for your phone:

-
- STEP 1** Press the **Setup** button.
 - STEP 2** Scroll to **Device Administration** and press **Select**.
 - STEP 3** Select **Set Password**.
 - STEP 4** Enter your old password (leave blank if you have never set a password). Press the **Down Arrow** key to go to **New Password**.
 - STEP 5** Enter your new numeric password. Press the **Down Arrow** key to go to **Re-enter New Password**.
 - STEP 6** Reenter the same password.
 - STEP 7** Press **Save**.
-

To delete a password:

-
- STEP 1** Press the **Setup** button.
 - STEP 2** Scroll to **Device Administration** and press **Select**.
 - STEP 3** Select **Set Password**.
 - STEP 4** Enter your old password. Press the **Down Arrow** key to go to **New Password**.

STEP 5 Leave the **New Password** and **Reenter New Password** fields empty.

STEP 6 Press **Save**.

Logging In and Logging Out of Your Phone

After you've set a password, you can log in and out of your phone. Logging out leaves the phone locked so that no one can access the directory, call history, user preferences, and other features on your phone.

If you are in a menu (for example, Directories) and are not logged in, the system prompts you for your password. Enter your password and press **Login**.

To log in through the Administration menu:

STEP 1 Press the **Setup** button.

STEP 2 Scroll to **Device Administration** and press **Select**.

STEP 3 Scroll to **Login** and press **Select**.

STEP 4 Enter your password and press **Login**.

Accessing Voicemail

To access voicemail, press the **Messages** button on your phone. Your system administrator should configure your phone with the correct voicemail number so that pressing the **Messages** button automatically dials your voicemail system.

If you need to change the number for your voicemail (for example, if your phone is not part of a Cisco SPA9000 Voice System and you have external voicemail), perform the following steps:

STEP 1 Press the **Setup** button.

STEP 2 Scroll to **User Preferences** and press **Select**.

STEP 3 Scroll to **Call Preferences** and press **Select**.

STEP 4 Scroll to **Voice Mail**.

-
- STEP 5** Enter the number to dial for voicemail. For a Cisco SPA9000 Voice System, this is normally “vmm.” For an external system, enter the phone number, including any digits you must dial to reach an outside line.



-
- TIP** To enter digits, press **Option** and choose **Input Num.** To clear the field of a previous entry, press **Option** and choose **Clear.**
-

- STEP 6** Press **Save.**
-

Using Advanced Phone Features

This chapter describes how to configure advanced features on your Cisco SPA525G IP phone. It contains the following sections:

- [Configuring Privacy and Security Features, page 67](#)
- [Creating and Using Speed Dials, page 69](#)
- [Playing MP3 Files on Your Phone, page 70](#)
- [Using the Paging Feature, page 72](#)
- [Customizing Your LCD Screen, page 73](#)
- [Using Ring Tones, page 76](#)
- [Accessing Weather and News on Your Phone, page 77](#)
- [Configuring Date and Time Parameters on Your Phone, page 79](#)
- [Using Star Codes, page 80](#)
- [Restarting Your Phone, page 82](#)
- [Viewing Phone, Network, and Call Information, page 82](#)
- [Viewing the Wireless Connection Status, page 84](#)
- [Advanced Menus for Technical Support Personnel, page 85](#)

Configuring Privacy and Security Features

You can also configure these features using your PC and the IP Phone Web Interface. See “[Blocking Caller ID](#),” on page 90 and the “[Blocking Anonymous Calls](#),” on page 91.

Blocking Caller ID

You can block Caller ID from your phone so that your phone number will not appear to the person you call.

To block Caller ID:

-
- STEP 1** Press the **Setup** button.
 - STEP 2** Scroll to **User Preferences** and press **Select**.
 - STEP 3** Select **Call Preferences**.
 - STEP 4** Scroll to **Block Caller ID** and press the **Right Arrow** key to choose **On**.
 - STEP 5** Press **Save**.
-

Blocking Anonymous Calls

Blocking anonymous calls prevents calls with unknown Caller ID from ringing your phone. (For example, if a caller set his phone to not display Caller ID, the call is considered anonymous.) These callers receive a busy signal or message when calling your phone if anonymous calls are blocked.

To block anonymous calls:

-
- STEP 1** Press the **Setup** button.
 - STEP 2** Scroll to **User Preferences** and press **Select**.
 - STEP 3** Select **Call Preferences**.

STEP 4 Scroll to **Block Anonym Call** and press the **Right Arrow** key to choose **On**.

STEP 5 Press **Save**.

Using Secure Call

With the secure call feature, the active call is encrypted so that others cannot eavesdrop. Before enabling Secure Call, ask your system administrator if Secure Call is available.



NOTE Your phone must be part of a Cisco SPA9000 Voice Network and your service provider must install a mini-certificate to enable this feature.

To use secure call:

STEP 1 Press the **Setup** button.

STEP 2 Scroll to **User Preferences** and press **Select**.

STEP 3 Select **Call Preferences**.

STEP 4 Scroll to **Secure Call** and press the **Right Arrow** key to choose **On**.

STEP 5 Press **Save**. When you dial, you will hear a tone before the call.

Enabling Dial Assistance

If you enable dial assistance, when you place calls, the LCD will display phone numbers based on the best matched entries in the Directory and Call History lists. To enable dial assistance:

STEP 1 Press the **Setup** button.

STEP 2 Scroll to **User Preferences** and press **Select**.

STEP 3 Select **Call Preferences**.

STEP 4 Scroll to **Dial Assist** and press the **Right Arrow** key to choose **On**.

STEP 5 Press **Save**.

If dial assistance is enabled, after beginning to dial, you can use the navigation button to scroll down, highlight a phone number on the LCD screen, and press dial to complete the call.

Creating and Using Speed Dials

You can configure up to 8 speed dials. Each speed dial can be a phone number, IP address or URL.

You can create and edit speed dials using your PC and the IP Phone Web Interface. See [“Creating Speed Dials,” on page 92](#).

To create or edit a speed dial:

STEP 1 Press the **Setup** button.

STEP 2 Scroll to **Speed Dials** and press **Select**.

STEP 3 For a new speed dial, scroll to select an unused speed dial location (2 through 9). You can have up to 8 speed dials (location 1 is reserved for voice mail). To edit a previously existing speed dial, select it.

STEP 4 Press **Edit**.

STEP 5 Enter the name and phone number for the speed dial.



TIP To select a contact from the Address Book, press **Option** and select **Select From Address Book**. Scroll to choose the contact and press **Select**.

STEP 6 Press **Save**.

To call one of your configured speed dial numbers, choose one of the following options:

- Open a phone line and press the number for the speed dial, then wait a few seconds or press **Dial**.
- Press the **Setup** button, select **Speed Dial**, choose the number, and press **Dial**.

Playing MP3 Files on Your Phone

Your phone contains an audio player that can play .mp3 files. To play music on your phone, you must load the audio files onto a USB memory device (not sold with the phone). The phone reads the files from the device, so the device must remain inserted while playing the files.



NOTE Only MP3 music with no Digital Media Rights protection can be played on the SPA525G IP Phone.

Creating the Playlist



NOTE The MP3 playlist on the SPA525G is limited to 48 songs.

- STEP 1** Connect a USB storage device to your PC.
- STEP 2** Create a directory named “**mp3**” on the USB device and copy the audio files into that directory.
- STEP 3** Remove the USB device from your PC and insert it into the USB slot on the SPA525G.
- STEP 4** Press the **Setup** button.
- STEP 5** Scroll to **MP3 Player** and press **Select**.
- STEP 6** Press **Add List** to create a playlist from the songs on the USB device.
- STEP 7** Choose songs by choosing one of the following methods:

- Choose individual songs by scrolling to the song you want and pressing the **Right Arrow** key or the **Select** button.
- Choose all songs on the USB device by pressing **SelectAll**.

You can clear all selected songs by pressing **ClearAll**.

STEP 8 After choosing songs, the songs will be marked with a check in the box next to the song. Press **Add** to add the selected songs to the playlist.

Playing Songs

In the Playlist, scroll to the song you want to begin playing and press **Play**.

You have the following controls:

- **Stop**—Stop the song. Pressing play will restart song play.
- **Previous**—Move to the previous song in the playlist.
- **Next**—Move to the next song in the playlist.
- **Back**—Move back one screen to the playlist.

Controlling the Audio

Use the **Volume** button on the phone to turn the music up or down.

To switch the audio destination between the speaker, headset, and handset, press the **Up Arrow** or **Down Arrow** key. The icon on the left above the song length display shows the audio destination of speaker, handset, or headset (see the following graphic).



Changing the Left and Right Channel for Stereo Headsets

When using a stereo headset inserted into the SPA525G, you may need to switch the audio left and right channels to hear the correct audio channel in the right or left ear. To change the audio:

-
- STEP 1** Press the **Setup** button.
 - STEP 2** Scroll to **User Preferences** and press **Select**.
 - STEP 3** Scroll to **Audio Preferences** and press **Select**.
 - STEP 4** Press the **Right Arrow** key to set Swap L/R Channel to **On**.
 - STEP 5** Press **Save**.
-

Using the Paging Feature

Your SPA525G can automatically answer pages from other Cisco SPA phones in the Cisco SPA9000 Voice System. When your phone is paged, the phone emits a series of beeps, and two-way audio is established between your phone and the phone that called you. You do not have to accept the page.



NOTE Your phone must be part of a Cisco SPA9000 Voice Network to use this feature.

Paging Another Phone

To page another phone, dial *96 plus the extension of the phone you are paging. If the phone you are paging is not set up to auto answer pages, the call will ring as a normal voice call.

Configuring Auto Answer

To configure your phone to auto answer pages:

-
- STEP 1** Press the **Setup** button.
 - STEP 2** Scroll to **User Preferences** and press **Select**.
 - STEP 3** Select **Call Preferences**.
 - STEP 4** Scroll to **Auto Answer Page**. Press the **Right Arrow** key to choose **On**.
 - STEP 5** Press **Save**.
-

Customizing Your LCD Screen

You can customize your LCD screen in the ways described below.

Changing the LCD Screen Contrast

To adjust the contrast of the LCD screen:

-
- STEP 1** Press the **Setup** button.
 - STEP 2** Scroll to **User Preferences** and press **Select**.
 - STEP 3** Scroll to **Screen Preferences** and press **Select**.
 - STEP 4** Scroll to **Display Brightness**. The default contrast is 15. Enter a number between 1 (lowest) and 15 (greatest) to change the contrast.
 - STEP 5** Press **Save**.
-

Setting the Screen Backlight Timer

You can set a timer for your screen so that your LCD screen becomes dark after a specified time when the phone is idle.

-
- STEP 1** Press the **Setup** button.
 - STEP 2** Scroll to **User Preferences** and press **Select**.
 - STEP 3** Scroll to **Screen Preferences** and press **Select**.
 - STEP 4** Scroll to **Backlight**. Press the **Right Arrow** key to choose **On**, which means that the darkening feature is enabled.
 - STEP 5** Scroll to **Backlight Timer**. Enter the number of seconds before the display should shut off after the phone is idle.
 - STEP 6** Press **Save**.
-

Configuring the Phone Screen Saver

You can enable your phone's screen saver and specify its appearance and the amount of time for the phone to be idle before it begins.

To configure your screen saver:

-
- STEP 1** Press the **Setup** button.
 - STEP 2** Scroll to **User Preferences** and press **Select**.
 - STEP 3** Scroll to **Screen Preferences** and press **Select**.
 - STEP 4** With Screen Saver highlighted, press the **Right Arrow** key to choose **On**.

-
- STEP 5** Scroll to **Screen Saver Settings** and press the **Right Arrow** key to choose the settings:
- Screen Saver Type—Choose from:
 - Black Background—Displays a black screen.
 - Gray Background—Displays a gray screen.
 - Black/Gray Rotation—The screen incrementally cycles from black to gray.
 - Picture Rotation—The screen rotates through available pictures that your system administrator has made available on the phone.
 - Digital Frame—Shows the background picture.
 - Trigger Interval—Enter the number of seconds that the phone remains idle before the screen saver turns on.
 - Refresh Interval—Enter the number of seconds before the screen saver should refresh (if, for example, you chose a rotation of pictures).
- STEP 6** Press **Save**.
-

Changing the Phone Wallpaper

You can change the background picture on your phone to one stored in the phone, or to one on a USB memory device attached to the phone.

If you are going to use a picture from the USB memory device, perform the following steps:

-
- STEP 1** Connect a USB storage device to your PC.
- STEP 2** Create a directory named “**pictures**” on the USB device and copy the image files into that directory. Image files must be between 30K and 300K in size. The phone can only read 45 images from the USB device.
- STEP 3** Remove the USB device from your PC and insert it into the USB slot on the SPA525G.
-

To change the background picture on your phone:

-
- STEP 1** Press the **Setup** button.
 - STEP 2** Scroll to **User Preferences** and press **Select**.
 - STEP 3** Scroll to **Screen Preferences** and press **Select**.
 - STEP 4** Scroll to **Wallpaper**. Press the **Right Arrow** key to select an image to use as the wallpaper.
 - STEP 5** Use the navigation arrows to choose an image. Press **Select** to choose the image, or to preview how the image will look on your phone, select the image and press **View**. Press **Select** to choose the image, or use the **Previous**, **Next**, and **Back** keys.
 - STEP 6** Press **Save**.
-

Using Ring Tones

Each extension of your phone can have a different ring tone.

To change a ring tone:

-
- STEP 1** Press the **Setup** button.
 - STEP 2** Scroll to **User Preferences** and press **Select**.
 - STEP 3** Scroll to **Audio Preferences** and press **Select**.
 - STEP 4** Scroll to the extension for which you want to select a ring tone and press the **Right Arrow** key.
 - STEP 5** Scroll through the ring tones and press **Play** to play the highlighted ring tone. Press **Select** to choose the highlighted ringtone for that extension.
-

Accessing Weather and News on Your Phone

You can access some pre-configured weather and news web services on your IP phone (if enabled by your system administrator). To access these services:

-
- STEP 1** Press the **Setup** button.
 - STEP 2** Select **Web Applications**.
 - STEP 3** Select the type of service.
-

Accessing Weather Information

You can view weather information for a maximum of three cities.

To add a city:

-
- STEP 1** In the Web Applications screen, select **Weather**.
 - STEP 2** Press **Add**.
 - STEP 3** Enter the city name or zip code, and press **Search**.
 - STEP 4** Select the city from the list of results and press **Add**.
-

To view a city:

-
- STEP 1** In the Web Applications screen, select **Weather**.
 - STEP 2** Weather information for the first entry in the list of cities is displayed. To view other cities on the list, press **List** and select the city. Then press **View**.



TIP Press **Refresh** to update weather information when viewing the weather screen.

To edit the list of cities:

STEP 1 In the Web Applications screen, select **Weather**.

STEP 2 To move entries up or down in the list or delete an entry, select the city you want to move, press **Option**, and choose **Move Up**, **Move Down**, or **Delete**.

Accessing News

STEP 1 In the Web Applications screen, select **News**.

STEP 2 Scroll to select the type of news you want to view:

- Local
- World
- Finance
- Sports
- Politics

STEP 3 Press **Select** to bring up the list of articles and use the **Up** and **Down Arrow** to scroll through them.

STEP 4 Press **View** to read an article, using the **Down Arrow** to scroll through the article. Press **Prev** or **Next** to go to other articles in the news category.

Configuring Date and Time Parameters on Your Phone

The date and time for your phone normally come from the phone server. However, if you need to change some date and time parameters, you can follow these steps:

-
- STEP 1** Press the **Setup** button.
- STEP 2** Scroll to **Device Administration** and press **Select**.
- STEP 3** Scroll to **Date/Time** and press **Select**.
- STEP 4** Scroll to the date and time setting that you want to change:
- **Time Zone**—Adds or subtracts hours to Greenwich Mean Time, or Western European Time. Press the **Right Arrow** key to change the time zone. Press **Save**.
 - **Daylight Saving**—Adjusts the time on your phone at the twice-yearly adjustment intervals for Daylight Saving Time. Press the **Right Arrow** key to turn Daylight Saving Time to **On** or **Off**.
 - **Automatic Mode**—Configures your phone to receive the time and date from the phone server. Press the **Right Arrow** key to turn automatic mode to **On** or **Off**. Press **Save**.
 - **NTP Server 1** and **NTP Server 2**—Configures your phone to receive the time and date from a Network Time Protocol server. Enter the name or the IP address of the server and press **Save**.
 - **Set Current Time Manually**—Press the **Right Arrow** key to choose the date and time. Use the **Right Arrow** key to move between the year, month, date, hour, and minute. Use the **Up** and **Down Arrow** keys to change the time. Press **Set**.



NOTE If your phone is connected to an administration server, any changes you make to the date and time will be lost when rebooting the phone.

Using Star Codes

The SPA525G supports numerous “star codes” to access phone supplementary services. These codes, which start with *, are entered before dialing a telephone number and provide services. For example, to block caller ID (star code 67), you would dial *67, followed by the telephone number you are calling.

Following is a list of supported star codes:

Code	Definition
03	Request media loopback for a call to monitor Voice over IP quality.
16	Activate Secure Call feature for all calls.* See Using Secure Call, page 68 .
17	Deactivate Secure Call feature for all calls.* See Using Secure Call, page 68 .
18	Activate Secure Call feature for a single call.* See Using Secure Call, page 68 .
19	Deactivate Secure Call feature for a single call.* See Using Secure Call, page 68 .
36	Pick up a call at another extension.* See Picking Up a Call, page 54 .
37	Pick up a group call.* See Picking Up a Call, page 54 .
38	Park a call.* See Parking a Call, page 55 .
39	Unpark a call.* See Parking a Call, page 55 .
66	Activate Call Back. Causes the SPA525G to repeatedly dial a busy number until the called party rings or answers.
69	Calls the last number that called your phone.
72	Activate Call Forward All. See Forwarding Calls, page 50 .
73	Deactivate Call Forward All. See Forwarding Calls, page 50 .
77	Activate anonymous call blocking. See Blocking Anonymous Calls, page 67 .
86	Deactivate Call Back.

Code	Definition
87	Deactivate anonymous call blocking. See Blocking Anonymous Calls, page 67 .
90	Activate Call Forward Busy. See Forwarding Calls, page 50 .
91	Deactivate Call Forward Busy. See Forwarding Calls, page 50 .
92	Activate Call Forward No Answer. See Forwarding Calls, page 50 .
93	Deactivate Call Forward No Answer. See Forwarding Calls, page 50 .
96	Page an extension.** See Paging Another Phone, page 72 .
01729	Configure the phone to prefer the G729 codec for all calls.
02729	Force the phone to prefer the G729 codec for all calls.
017110	Configure the phone to prefer the G711u codec for all calls.
017111	Configure the phone to prefer the G711a codec for all calls.
027110	Force the phone to use the G711u codec for all calls.
027111	Force the phone to use the G711a codec for all calls.
0172632	Configure the phone to prefer the G726r32 codec for all calls.
0272632	Configure the phone to force the G726r32 codec for all calls.

*Requires that your SPA525G phone be part of a Cisco SPA9000 Voice System network.

**Requires that the paged extension be part of a Cisco SPA9000 Voice System network.

Restarting Your Phone

Occasionally you may need to restart your phone if the screen locks up. To restart your phone:

-
- STEP 1** Press the **Setup** button.
 - STEP 2** Scroll to **Device Administration** and press **Select**.
 - STEP 3** Scroll to **Restart** and press **Select**.
-

Viewing Phone, Network, and Call Information

The SPA525G provides menus to view information about your phone.

Viewing Phone Information

To view information about your phone:

-
- STEP 1** Press the **Setup** button.
 - STEP 2** Scroll to **Status** and press **Select**.
 - STEP 3** Select **Product Information**. You can view the following information:
 - Product Name
 - Serial Number
 - MAC (Hardware) Address
 - Software Version
 - Hardware Version
 - Certificate
 - Customization
-

Viewing Network Information

To view network information for your phone:

STEP 1 Press the **Setup** button.

STEP 2 Scroll to **Status** and press **Select**.

STEP 3 Scroll to **Network Status** and press **Select**. You can view the following information:

- Network Type
- Network Status
- Addressing Type
- IP Address
- Subnet Mask
- Default Router
- Primary DNS
- Secondary DNS
- MAC (Hardware) Address

Viewing Phone Line and Extension Information

To view phone line and extension information:

STEP 1 Press the **Setup** button.

STEP 2 Scroll to **Status** and press **Select**.

-
- STEP 3** Scroll to **Phone Status** and press **Select**. You can view the following information:
- **Phone Status**—Up time and packets sent/received
 - **Extension Status**—If an extension is registered, when it was registered, and more
 - **Line Status**—Active calls and call information
 - **Provisioning Status**—If a profile rule was used, and the status
 - **Call Statistics History**—Information about individual calls.
-

Viewing Peripheral Status

To view information about phone peripherals, such as a USB memory stick or a SPA932 attendant console:

-
- STEP 1** Press the **Setup** button.
- STEP 2** Scroll to **Status** and press **Select**.
- STEP 3** Scroll to **Peripheral Status** and press **Select**. You can view the following information:
- USB Status
 - Attendant Console Status
-

Viewing the Wireless Connection Status

If you have set up your wireless connection (described in "[Connecting Your Phone to the Wireless Network](#)" section on page 34), you can view the status of your wireless connection.

-
- STEP 1** Press the **Setup** button.
- STEP 2** Scroll to **Network Configuration** and press **Select**.

STEP 3 Select **Wi-Fi Configuration** and press the **Right Arrow** key.

STEP 4 Scroll to **Wireless Status** and press **Select**. The status, SSID name, and signal strength are displayed. Press **Detail** for more information.

Advanced Menus for Technical Support Personnel



CAUTION

These menus are used to configure and troubleshoot your phone and the phone network. You should not change these settings or perform these actions unless directed to do so by your Administrator.

Settings Menu

Network Configuration:

- Connection Type
- Static IP Address Settings
- CDP
- VLAN
- VLAN ID
- Multicast Address

Device Administration:

- Factory Reset
- Custom Reset
- Profile Rule
- Call Control Settings

Using the Web Interface

The Cisco SPA525G provides a web interface to the phone that allows you to configure some features of your phone using a web browser. This chapter contains the following sections:

- [Configuring Your Address Book, page 87](#)
- [Setting Do Not Disturb, page 88](#)
- [Configuring Call Forwarding, page 89](#)
- [Configuring Call Waiting, page 90](#)
- [Blocking Caller ID, page 90](#)
- [Blocking Anonymous Calls, page 91](#)
- [Viewing Call History Lists, page 91](#)
- [Creating Speed Dials, page 92](#)
- [Configuring Wi-Fi, page 92](#)
- [Configuring Bluetooth, page 93](#)
- [Upgrading Firmware, page 94](#)

Logging in to the Web Interface

-
- STEP 1** Obtain the IP address of your phone by pressing the **Setup** button and selecting **Status**.
 - STEP 2** Scroll to **Network Status** and press **Select**. Note the **IP address**.
 - STEP 3** On your PC, open Internet Explorer.
 - STEP 4** Enter the IP address in the browser's toolbar.
 - STEP 5** The **Info** page of the IP Phone Web Interface displays.

The web interface has several different tabs. The tabs that allow you to configure options on your phone are the **Phone** and **User** tabs. Click the tab names to switch between these tabs.

Configuring Your Address Book

The Cisco SPA525G phone provides an address book for you to store and view frequently dialed numbers. The address book appears on your phone, and you can dial numbers from the directory.

To view and edit your address book:

-
- STEP 1** Log in to the web interface.
 - STEP 2** Choose the **Personal Address Book** tab. A window appears with the listings for your address book.
-

To enter a new contact into the address book:

-
- STEP 1** In the Personal Address Book tab, click **Add Personal Address Entry**.
 - STEP 2** Enter the name, office number, home number, or mobile number, and ring tone for the new contact.
 - STEP 3** Click **Submit All Changes**. The contact is added to your address book.

STEP 4 (Optional) To add the contact to a speed dial:

- a. Click the **Phone** icon under Speed Dials.
- b. Choose the phone (office, home, or mobile) that you want to add as a speed dial.
- c. Choose the speed dial position to assign the contact.
- d. Press **Confirm**.

To remove a contact from the address book:

STEP 1 In the Personal Address Book tab, check the box next to the contacts you want to remove. To select all contacts, check the box at the top of the column.

STEP 2 Press **Remove**.

STEP 3 Press **OK**. The contacts are removed from your address book.

To edit a contact's information:

STEP 1 In the Personal Address Book tab, click the **Edit** icon in the row for that contact.

STEP 2 Enter the information and press **Submit All Changes**.

Setting Do Not Disturb

Use the Do Not Disturb feature to prevent incoming calls from ringing your phone. If you have voice mail configured, incoming callers immediately reach voice mail. If voice mail is not configured, callers hear a busy signal or message.

To set Do Not Disturb:

-
- STEP 1** Log in to the web interface.
- STEP 2** In the **Voice** tab, **User** menu, under **Supplementary Services**, locate the **Do Not Disturb** field.
- STEP 3** Choose **Yes** to turn on **Do Not Disturb**.
- STEP 4** At the bottom of the page, click **Submit All Changes**. Your phone reboots.



NOTE You can turn off Do Not Disturb from your phone or from the web interface.

Configuring Call Forwarding

-
- STEP 1** Log in to the web interface.
- STEP 2** In the **Voice** tab, **User** menu, under **Call Forward**, you can configure the following fields:
- **CFWD Setting**—Enables call forwarding.
 - **CFWD All Dest**—Forwards all calls to a single number that you enter.
 - **CFWD Busy Dest**—Forwards all calls to another number when the phone is busy. Enter the number to which to forward calls.
 - **CFWD No Ans Dest**—Forwards calls to another number if there's no answer at your phone. Enter the number to which to forward calls.
 - **CFWD No Ans Delay**—Number of seconds to delay forwarding calls, if there is no answer at your phone. Enter the number of seconds to delay.
- STEP 3** At the bottom of the page, click **Submit All Changes**. Your phone reboots.
-

Configuring Call Waiting

Call waiting alerts you when you are on a call with a status message and ringing that another call is incoming. If you turn call waiting off, incoming calls do not ring your phone if you are on another call, and the caller hears a busy signal or message.

To turn call waiting on or off:

-
- STEP 1** Log in to the web interface.
 - STEP 2** In the **Voice** tab, **User** menu, under **Supplementary Services**, locate the **CW Setting** field.
 - STEP 3** Choose **yes** or **no** to enable or disable.
 - STEP 4** At the bottom of the page, click **Save All Settings**. Your phone reboots.
-

Blocking Caller ID

You can block Caller ID from your phone so that your phone number will not appear to the person you call.

To block Caller ID:

-
- STEP 1** Log in to the web interface.
 - STEP 2** In the **Voice** tab, **User** menu, under **Supplementary Services**, locate the **Block CID Setting** field.
 - STEP 3** Choose **yes** or **no** to enable or disable.
 - STEP 4** At the bottom of the page, click **Save All Settings**. Your phone reboots.
-

Blocking Anonymous Calls

Blocking anonymous calls prevents calls with unknown Caller ID from ringing your phone. (For example, if a caller set his phone to not display Caller ID, the call is considered anonymous.) These callers receive a busy signal or message.

To block anonymous calls:

-
- STEP 1** Log in to the web interface.
 - STEP 2** In the **Voice** tab, **User** menu, under **Supplementary Services**, locate the **Block ANC Setting** field.
 - STEP 3** Choose **yes** or **no** to enable or disable.
 - STEP 4** At the bottom of the page, click **Save All Settings**. Your phone reboots.
-

Viewing Call History Lists

To view Call History Lists:

-
- STEP 1** Log in to the web interface.
 - STEP 2** Choose the **Call History** tab. A window appears with the call history for your phone. Select a call history list to show from the drop-down list:
 - **All Calls**—All calls placed to and from your phone.
 - **Placed Calls**—Shows information for the last 60 numbers dialed from your phone.
 - **Received Calls**—Shows information for the last 60 answered calls.
 - **Missed Calls**—Shows the last 60 missed calls.
 - STEP 3** (Optional) To add a call from one of these lists to your address book, click the **Address Book** icon under the **Add** column. Edit any information and press **Submit All Changes**.
-

Creating Speed Dials

You can configure up to 8 speed dials. Each speed dial can be a phone number, IP address or URL.

To create or edit a speed dial:

-
- STEP 1** Log in to the web interface.
 - STEP 2** Choose the **Speed Dials** tab.
 - STEP 3** Enter the name and number for the speed dial entries you want to create or edit. Remember to enter any digits you must dial to reach an outside line.
 - STEP 4** Click **Submit All Changes**.
-

Configuring Wi-Fi

You can configure your Wi-Fi connection from the web interface. See [Connecting Your Phone to the Wireless Network, page 34](#) for more information on the types of wireless connections supported.

To configure your wireless connection:

-
- STEP 1** Log in to the web interface.
 - STEP 2** Choose the **Wi-Fi** tab.
 - STEP 3** Ensure **Wireless Enable** is set to **On**.
 - STEP 4** To manually enter a Wi-Fi profile, choose **Wi-Fi Profile** from the Wi-Fi Device list and proceed to the next section. To use WPS, choose **Wi-Fi Protected Setup** and follow the on-screen instructions
-

You can enter up to three wireless profiles. To create a wireless profile:

-
- STEP 1** In the Wi-Fi tab, ensure **Wi-Fi Profile** is selected in the Wi-Fi Device box.
 - STEP 2** (Optional) To scan for available wireless networks, click **Site Survey**. Click the icon under **Add** in the row of the wireless network you want to select.
 - STEP 3** Click **Add New Wi-Fi Profile**.
 - STEP 4** Enter or edit (if you performed Step 2) the name, SSID, security mode, and security parameters. (See [Connecting Your Phone to the Wireless Network, page 34](#) for more information on security.)
 - STEP 5** Click **Submit**. The wireless profile is added to the list.
 - STEP 6** Click **Submit All Changes**.
-

Configuring Bluetooth

You can use a Bluetooth headset with your phone and configure it from the web interface.

-
- STEP 1** Log in to the web interface.
 - STEP 2** Choose the **Bluetooth Configuration** tab.
 - STEP 3** Ensure Bluetooth Device is set to **On**.
 - STEP 4** To scan for your headset, click **Search Bluetooth Device**.
 - STEP 5** If found, your device appears in the Bluetooth Device List.
 - STEP 6** Click the name for your device.
 - STEP 7** Enter your PIN and press **Submit All Changes**.
-

Upgrading Firmware



IMPORTANT: If you are using your phone with an Internet Telephony Service Provider's system, **do not upgrade your phone's firmware without consulting your service provider.** Your provider may automatically upgrade your phones without any action on your part necessary.

Before upgrading your firmware, you need to download the latest version from <http://www.cisco.com/go/smallbiz>. Unzip the file to your PC.

-
- STEP 1** Log in to the web interface.
 - STEP 2** Choose the **Firmware Upgrade** tab.
 - STEP 3** Click **Firmware Upgrade Window**.
 - STEP 4** Browse to select the firmware file from your PC. Click **Submit**. The firmware is installed and your phone reboots.
-

Using the SPA932 Attendant Console

This chapter describes how to install and use the SPA932 Attendant Console with your SPA525G IP Phone.

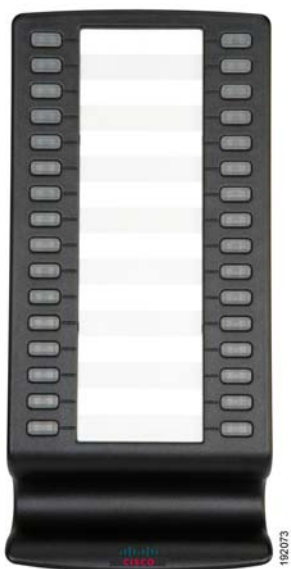

Figure 1 SPA932 Attendant Console

The SPA932 is a 32-button attendant console for the SPA525, providing 32 three-color (red, green, and orange) programmable LEDs, with support for Broadsoft Busy Lamp Field and Asterisk Line Monitoring. The SPA932 attaches to the SPA525 with the attachment arm provided. It obtains power directly from the SPA525 and does not require a separate power supply. Two SPA932 units can be attached to a single SPA525 to monitor a total of 64 separate lines.

Connecting the SPA932 Attendant Console to the SPA525G IP Phone

To connect the SPA932 Attendant Console to the SPA525G IP phone, you need the following:

- SPA932 Attendant Console
- Attachment Arm
- Two (2) Attachment Arm Screws
- Auxiliary Cable
- Desktop Stand

Connecting a Single SPA932

- STEP 1** Turn both the SPA525G and SPA932 face down.
- STEP 2** Align the hole in the SPA525G alignment recess with the hole on the attachment arm.
- STEP 3** Using the attachment arm screw, secure the attachment arm to the SPA525G.



Using the SPA932 Attendant Console

Connecting the SPA932 Attendant Console to the SPA525G IP Phone

6

- STEP 4** Align the hole in the SPA932 alignment recess with the hole on the attachment arm.
- STEP 5** Using the attachment arm screw, secure the attachment arm to the SPA932.



192075

- STEP 6** Locate the AUX IN port on the back of the SPA932. Connect one end of the auxiliary cable to this port.



IMPORTANT: Do not plug a telephone line cord into an AUX port. Use only the auxiliary cable provided with the SPA932.



- STEP 7** Locate the AUX port on the back of the SPA525G. Connect the other end of the auxiliary cable to this port.



- STEP 8** Route the auxiliary cable inside the cable relief channel in the SPA932.
- STEP 9** Attach the appropriate desktop stand to each unit. The SPA932 is powered via the auxiliary cable with the SPA525G.

Connecting an Additional SPA932



NOTE: A maximum of two SPA932 Attendant Consoles can be connected to a SPA525G.

- STEP 1** Align the hole in the first SPA932 alignment recess with the hole on the attachment arm.
- STEP 2** Using the attachment arm screw, secure the attachment arm to the first SPA932.



- STEP 3** Align the hole in the second SPA932 alignment recess with the hole on the attachment arm.
- STEP 4** Using the attachment arm screw, secure the attachment arm to the second SPA932.
- STEP 5** Locate the AUX OUT port on the back of the first SPA932. Connect one end of the auxiliary cable to this port.



IMPORTANT: Do not plug a telephone line cord into an AUX port. Use only the auxiliary cable provided with the SPA932.

- STEP 6** Locate the AUX IN port on the back of the second SPA932. Connect the other end of the auxiliary cable to this port.



- STEP 7** Route the auxiliary cable inside the cable relief channel.
- STEP 8** Attach the appropriate desktop stands to each unit. The SPA932 is powered via the auxiliary cable with the SPA525G. No additional power source is required.

Using the SPA932 Attendant Console with Your SPA525G IP Phone

The SPA932 can be configured to easily access other phone lines in the system. For example, buttons on the 932 can be configured to monitor another extension, speed dial a number, transfer calls to another extension, and more.

Configuration of the SPA932 and assignment of the line buttons is performed by the system administrator and is not described in this document. See the *Cisco SPA and Wireless IP Phone Administration Guide* for more information on this subject.

The functions of SPA932 buttons may differ depending on configuration. However, in general, you can:

- Monitor an extension by viewing its color. A steady red color usually indicates the extension is in use. A green color indicates the line is free. Blinking red indicates the line is ringing. Orange indicates a line error. A line button with no color is not configured.
- Transfer a call by pressing the line button on the SPA932 when an incoming call is ringing.
- Dial a configured extension by pressing the green line button on the SPA932.
- Pick up a call ringing at the extension by pressing the flashing red line button.

Monitoring the SPA932

To view the status of the SPA932, perform the following steps:

-
- STEP 1** Press the **Setup** button.
 - STEP 2** Scroll to **Status** and press **Select**.
 - STEP 3** Scroll to **Peripheral Status** and press **Select**.
 - STEP 4** The status is shown in the “Sidecar” fields.
-



Additional Information

Regulatory Compliance and Safety Information

Regulatory Compliance and Safety Information for this product is available on Cisco.com at the following location:

www.cisco.com/go/smallbiz

Warranty

Warranty information that applies to this product is available on Cisco.com at the following location:

www.cisco.com/go/smallbiz

End User License Agreement (EULA)

Licensing information that applies to this product is available on Cisco.com at the following location:

www.cisco.com/go/eula

Support Contacts

Support contact information for this product is available on Cisco.com at the following location:

www.cisco.com/go/support

Where to Go From Here

Cisco provides a wide range of resources to help you obtain the full benefits of the Cisco SPA525G.

Product Resources

Website addresses in this document are listed without **http://** in front of the address because most current web browsers do not require it. If you use an older web browser, you may have to add **http://** in front of the web address.

Resource	Link
Cisco Partner Central (requires partner registration and login)	www.cisco.com/web/partners/sell/smb/
Cisco Small Medium Business Product Information	www.cisco.com/go/smallbiz

Related Documentation

The following table describes related documents that Cisco provides to help you use your Cisco SPA525G IP Phone.

These documents and more are available at www.cisco.com/go/smallbiz.

Document Title	Description	Intended Audience
<i>Cisco Small Business Pro SPA IP Phone 525G Quick Start Guide</i>	Installation and initial configuration of your Cisco SPA525G IP Phone.	End Users, VARs, and Service Providers
<i>Cisco Small Business Pro SPA and Wireless IP Phone Administration Guide</i>	Administration and advanced configuration of your Cisco SPA525G IP Phone.	System Administrators, VARs, and Service Providers
<i>Cisco SPA9000 Voice System Setup Wizard User Guide</i>	Installation of your SPA9000 voice system and SPA IP phones using the setup wizard.	System Administrators, VARs, and Service Providers